

FM Choice

F100HP

Up to 5 A | 100 mil | ICT application



Electrical specifications

Current [A]	5
R _{TYP} [mOhm]	<20

Mechanical specifications

Temperature [°C]	-45°...+100°		
Preload [cN]	110	130	200
Spring force [cN] at nt ±20%	150	200	300
Nominal travel [mm]	4.3	4.3	4.3
Maximum travel [mm]	6.4	6.4	6.4

Materials and plating

Plunger	BeCu	gold plated
Barrel	Nickel silver	gold plated
Spring	Spring steel	silver plated
Receptacle	Nickel silver	gold plated

Accessories

1010818	H100LA-7.6	Receptacle
1008392	FEWZ-100EV	Insertion tool receptacle
1003566	FDWZ-100	Insertion tool probe

* Overview of other receptacles H100 on page 34+35

Drill size recommendation (mm)

H100...	Press ring as stop	1.67 - 1.69
H100...	Press ring inserted	1.70 - 1.75





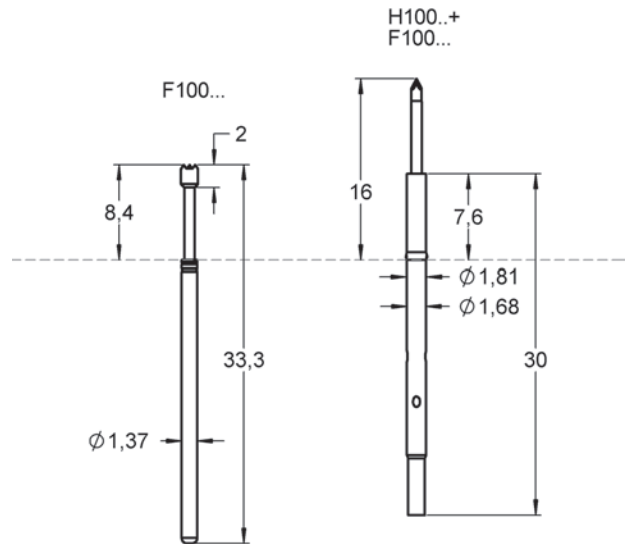









































Series drawing

All measurements are in mm.



Order code	Product name	Tip Style	Tip Ø [mm]	Material/Plating	Force [cN]	Thread [M]	Version	FM Choice
1135349	F10005B200P200HP	05	2.00	B / P	200	-	HP	FM Choice
1018941	F10006B150P300	06	1.50	B / P	300	-	-	FM Choice
1019980	F10006B200P300HP	06	2.00	B / P	300	-	HP	FM Choice

BASIC PROBES 100 MIL

Order code	Product name	Tip Style	Tip Ø [mm]	Material/Plating	Force [cN]	Thread [M]	Version	FM Choice
1030188	F10006B150P300IK03	06 	1.50	B / P	300	-	IK03	
1017617	F10010S060P150HPRP	10 	0.60	S / P	150	-	HPRP	-
1026144	F10010S060P300	10 	0.60	S / P	300	-	-	
1039808	F10010S060P300HP	10 	0.60	S / P	300	-	HP	
1034707	F10011B090P300	11 	0.90	B / P	300	-	-	
1137199	F10014S150P200HP	14 	1.50	S / P	200	-	HP	-
1001170	F10014S150P300HP	14 	1.50	S / P	300	-	HP	
1040481	F10015B150P150HP	15 	1.50	B / P	150	-	HP	
1026140	F10015B150P300	15 	1.50	B / P	300	-	-	
1036642	F10015B150P300HP	15 	1.50	B / P	300	-	HP	
1010207	F10021S090P200HP	21 	0.90	S / P	200	-	HP	
1010160	F10021S090P300HP	21 	0.90	S / P	300	-	HP	
1014293	F10032S090P300HP	32 	0.90	S / P	300	-	HP	
1018693	F10033S090P150HP	33 	0.90	S / P	150	-	HP	
1010205	F10033S090P200HP	33 	0.90	S / P	200	-	HP	
1026187	F10033S090P300	33 	0.90	S / P	300	-	-	
1009991	F10033S090P300HP	33 	0.90	S / P	300	-	HP	
1038017	F10035S150P200HP	35 	1.50	S / P	200	-	HP	
1036218	F10035S150P300	35 	1.50	S / P	300	-	-	
1036217	F10035S150P300HP	35 	1.50	S / P	300	-	HP	
1135612	F10037S050P200HP	37 	0.50	S / P	200	-	HP	
1014768	F10037S050P300HP	37 	0.50	S / P	300	-	HP	
1132220	F10038S090P300HP	38 	0.90	S / P	300	-	HP	-
1010206	F10043S090P200HP	43 	0.90	S / P	200	-	HP	
1010165	F10043S090P300HP	43 	0.90	S / P	300	-	HP	
1137813	F10054S157P200HP	54 	1.57	S / P	200	-	HP	-
1015552	F10062S090P150HP	62 	0.90	S / P	150	-	HP	
1010208	F10062S090P200HP	62 	0.90	S / P	200	-	HP	
1010167	F10062S090P300HP	62 	0.90	S / P	300	-	HP	
1137408	F10063B150P200HP	63 	1.50	B / P	200	-	HP	